

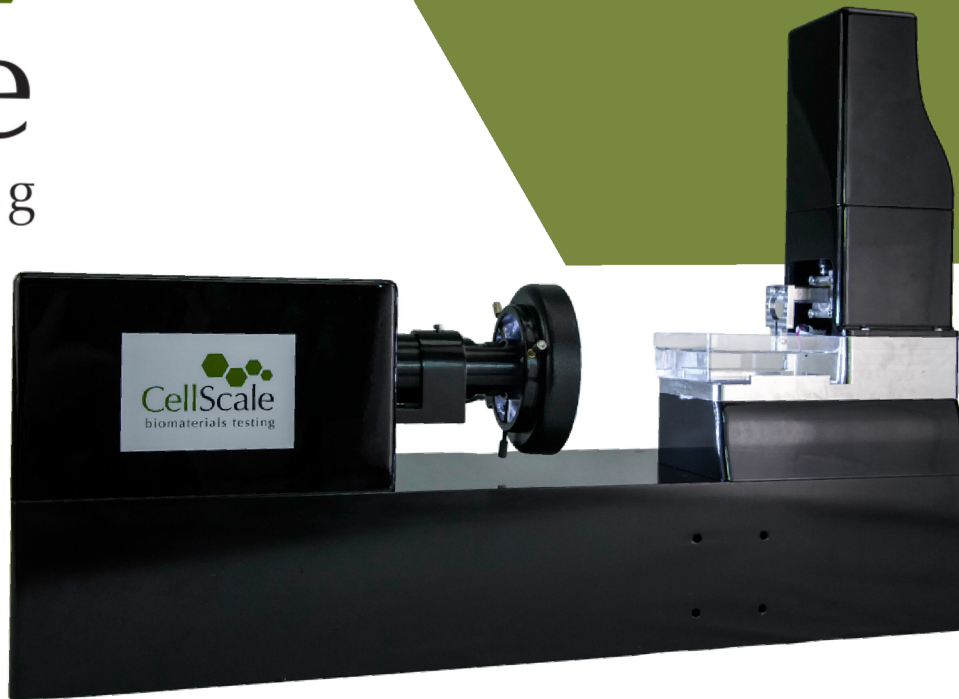

CellScale
biomaterials testing



MICROTESTER

CATALOGUE

2026

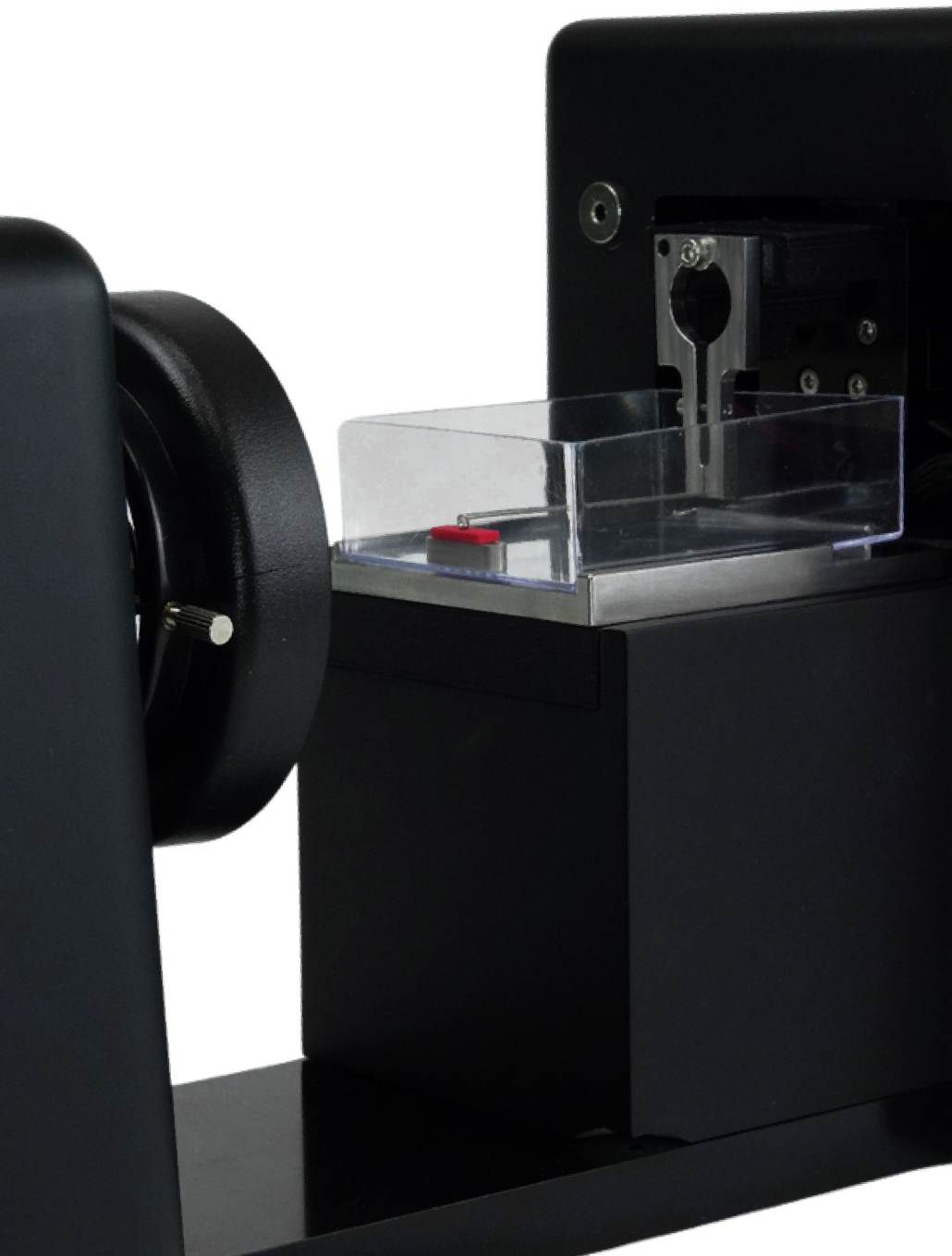
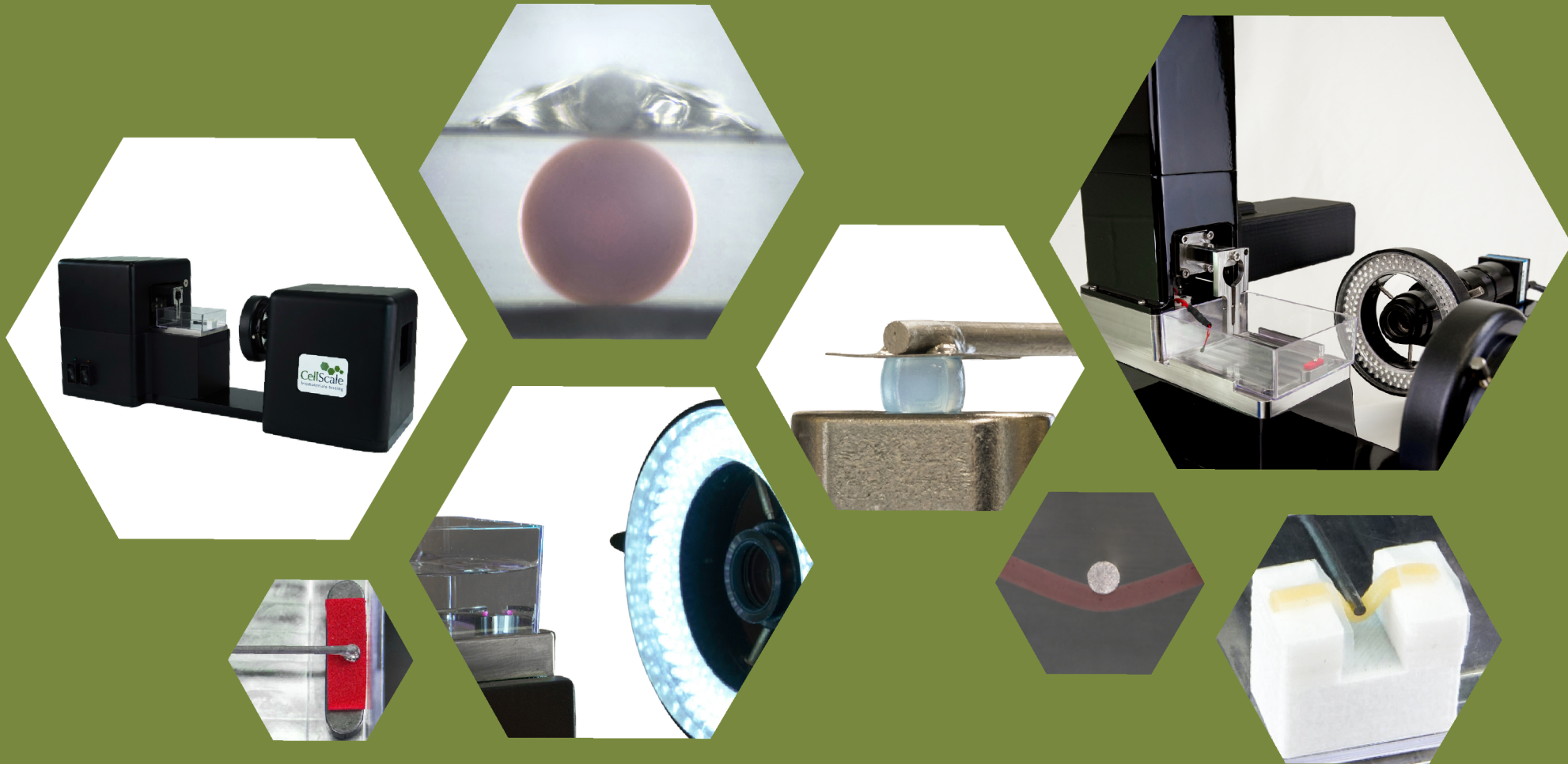

Table of Contents

MICROTESTER OVERVIEW	05
MICROTESTER MODELS	08
STANDARD FEATURES	12
IMAGING	14
MICROBEAMS	16
SOFTWARE	18
BUILD UPGRADES	20
ADDITIONAL TEST FIXTURES	23
ACCESSORIES	26
RESEARCH APPLICATIONS	28

A Precision Micro-Mechanical



Tester for Your Lab Bench

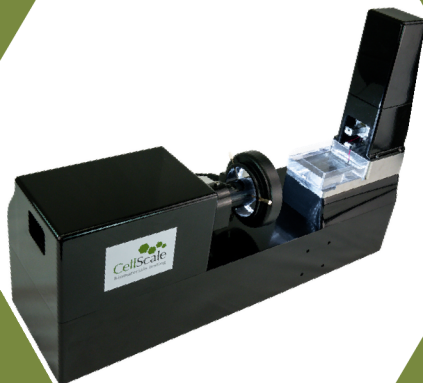
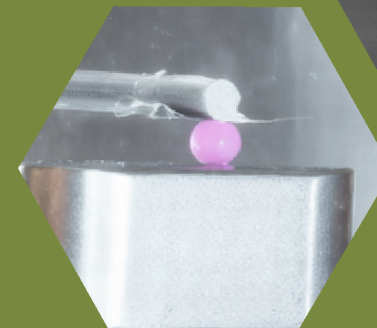
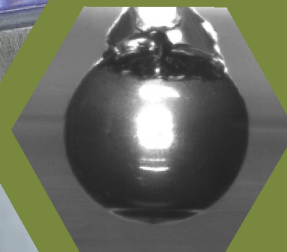
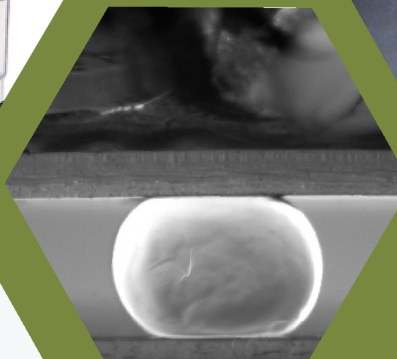
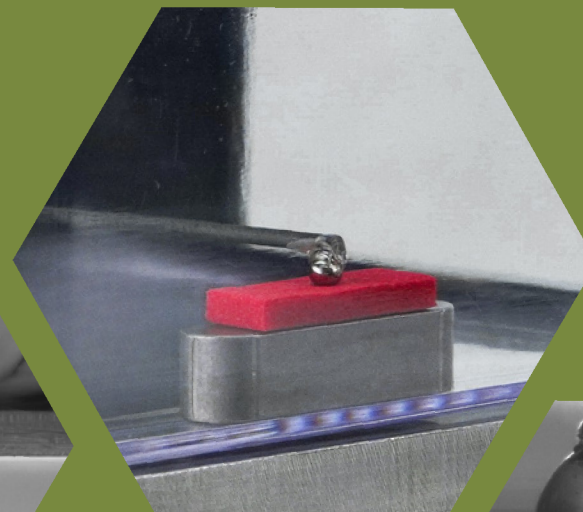

- RUN TEST
- Template Manager
- Data Analysis
- Hardware Tools

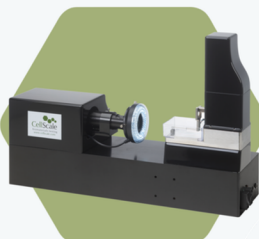

MicroTester Series

Benchtop Micro-Mechanical Testing Instruments

The MicroTester series is designed to deliver accurate and reproducible mechanical property data for very small, soft, and delicate specimens. Designed for precision and ease of use on the benchtop, the MicroTester supports a wide range of experimental needs in micro-mechanical testing, biomaterials research, mechanobiology, and tissue engineering.

The system is purpose-built for low-force compression, shear, indentation, and tension-type testing of samples on the millimeter and micrometer scale, making it well-suited for hydrogels, cell-laden constructs, spheroids, organoids, thin tissues, and other compliant materials that are difficult to evaluate on conventional mechanical testers. Multiple microbeam (force transducer) options allow users to match sensitivity to specimen stiffness and force range, supporting reliable measurement across a broad range of low-force applications.

Integrated imaging and environmental control are central to the MicroTester workflow, enabling quantitative optical measurement during testing under physiologically-relevant conditions. The imaging system supports synchronized image capture alongside force and displacement data, with capabilities for image-based strain validation and strain mapping in workflows where local deformation matters.

The MicroTester's compact footprint and research-focused design make advanced micro-scale mechanical testing accessible to laboratories that need high-quality force, displacement, and optical deformation data in a benchtop format. Intuitive software for test creation, control, and post-test analysis, together with configurable hardware and application-specific accessories, helps streamline workflows in both specialized and shared research environments.



Operating Principle

The MicroTester applies deformation with a flexible microbeam while using imaging and actuator motion to determine specimen deformation and applied force. This measurement approach gives the MicroTester high sensitivity for micro-scale specimens where conventional load cells often struggle with resolution, especially for soft materials, microtissues, organoids, microspheres, and hydrogels.

1 The actuator moves the base of the microbeam by a known amount

- G2 model: base motion is measured by a position feedback device on a piezo-electric actuator
- LT model: base motion is determined from controlled actuator microsteps

2 The imaging system tracks the microbeam tip in real time

- The tip position is measured optically, and the change in tip position from its starting location gives the specimen deformation

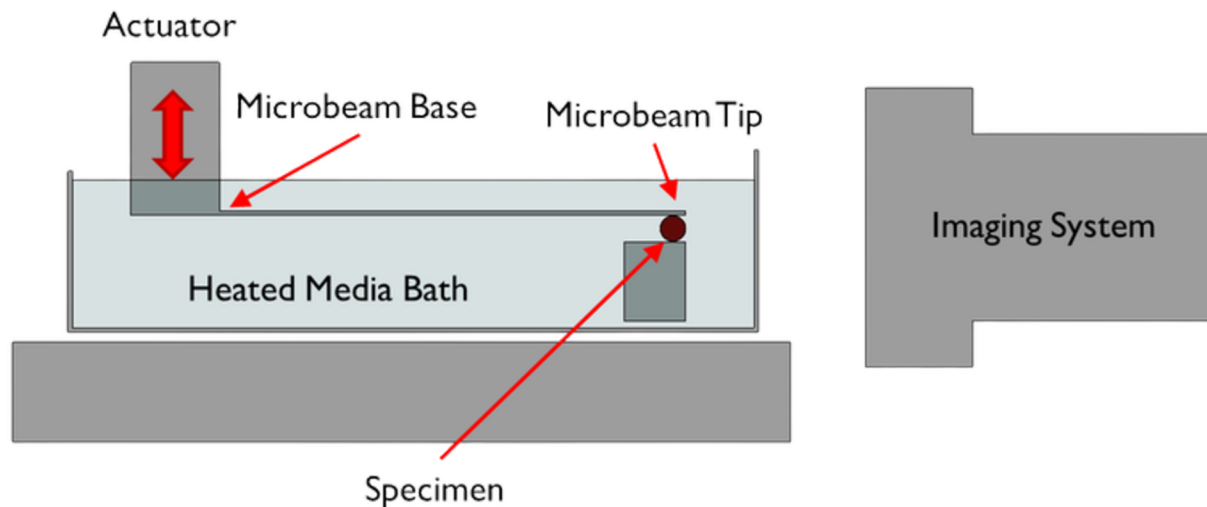

4 Force is calculated from microbeam deflection

- Since the microbeam acts as the force transducer, selecting the correct beam stiffness (determined by beam diameter) is important for sensitivity, resolution, and usable force range

3 Microbeam deflection is the difference between base motion and tip motion

- Some actuator travel deforms the specimen, and some bends the microbeam
- The system separates those two effects during the test

Capabilities



Micro-Mechanical
Testing



Compression
Testing

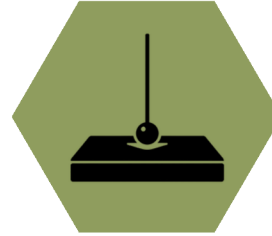

Indentation
Testing



3-Point Tensile
Testing



Shear
Testing



Digital Image
Correlation

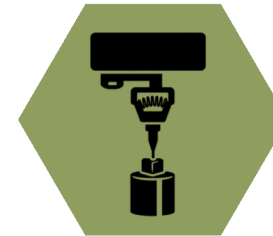

Ultra Low
Force Testing



Hydrated & Temperature
Controlled Testing



Viscoelastic & Time-
Dependent Testing

MicroTester Series

The MicroTester series includes two research-ready mechanical testing systems designed for micro-mechanical testing of very small, soft, and delicate specimens. Both models share the same core mechanical testing approach, with differences in actuator technology, data rate, imaging resolution, cycle performance, and upgrade flexibility.

Choose the Right Device for Your Testing Needs

The MicroTester LT is a compact entry system that provides reliable micro-scale testing with integrated imaging, strain mapping capability, and a heated media bath included for hydrated, temperature-controlled workflows. The MicroTester G2 builds on this foundation with a higher data rate and cycle performance, improved imaging resolution, a wider range for image field of view, finer actuator resolution with piezo-driven actuation, and optional upgrades for shear testing and a secondary camera, making it the more advanced, flexible, and high-resolution platform for more demanding research applications.



MicroTester LT



MicroTester G2

MicroTester LT

MicroTester LT

The MicroTester LT is a compact micro-mechanical testing system for ultra-low force testing of very small, soft, and delicate specimens. With stepper-driven actuation, imaging for synchronized visual analysis and strain-based measurement, media bath integration, and straightforward operation, it is well-suited for routine microscale mechanics workflows in biomaterials, mechanobiology, and tissue engineering research.

Application Examples

- Hydrogel compression testing
- Spherical indentation of soft materials
- Spheroid compression studies
- Viscoelastic testing of soft microscale samples
- Hydrated and temperature-controlled testing of compliant biomaterials
- Cell-laden hydrogel mechanical characterization
- Comparative stiffness testing of small tissue constructs
- Micro-scale testing of delicate specimens
- Routine benchtop testing in shared lab environments

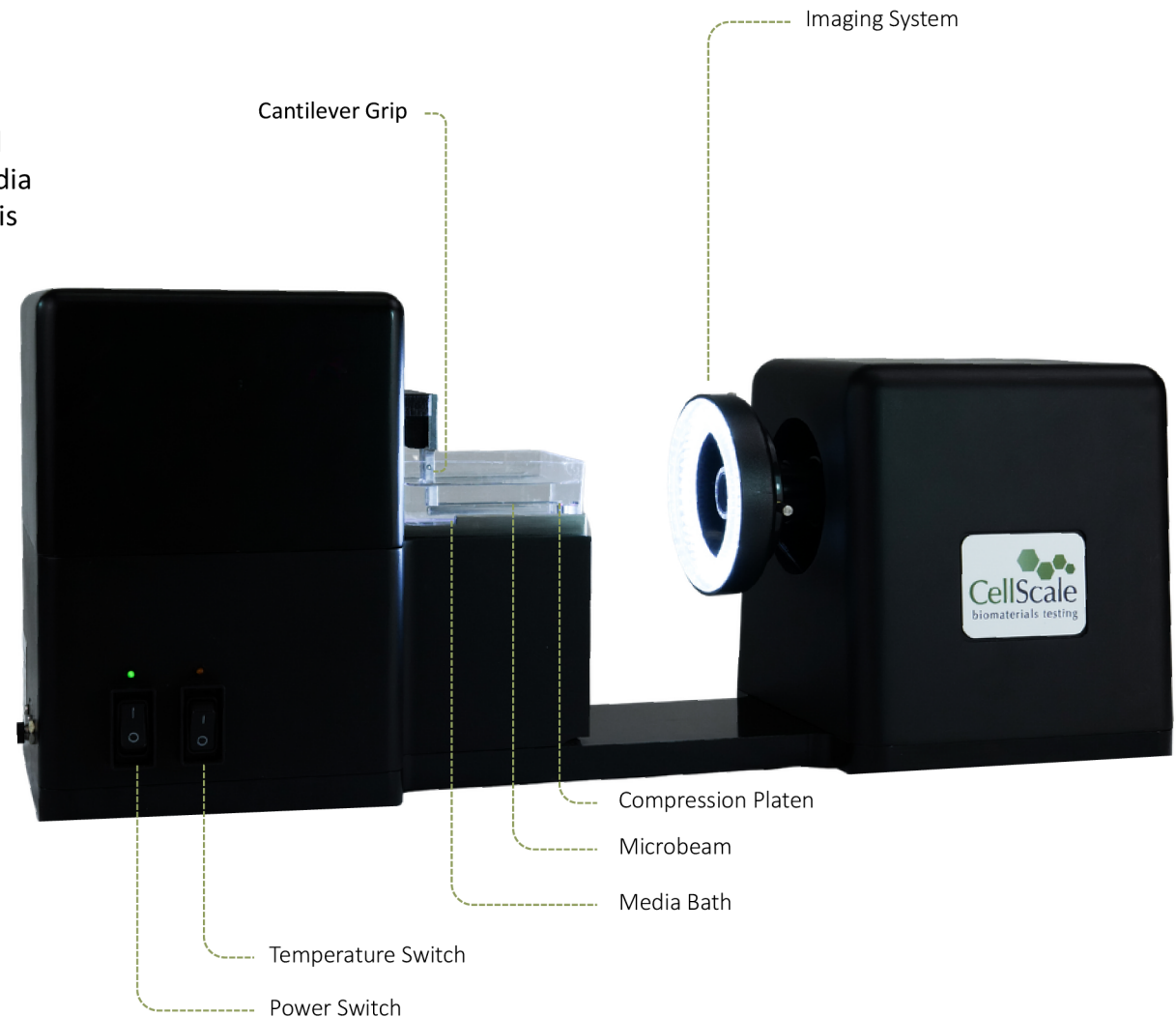

MicroTester G2

MicroTester G2

The MicroTester G2 is an advanced micro-mechanical testing system with the highest resolution for specialized microscale test workflows. With piezo-driven actuation, higher data rate and cycle capability, higher-resolution scientific imaging, and optional upgrades for secondary imaging and shear testing, it is designed for research that demands greater performance, flexibility, and experimental control for the widest range of sample dimensions.

Application Examples

- Organoid, cell aggregate, and microtissue mechanics
- High-resolution compression testing of hydrogels and soft biomaterials
- Tension testing of thin, delicate, or low-force specimens
- Shear testing of soft materials and interfaces
- Local mechanical characterization by spherical indentation
- Strain measurement and strain mapping during microscale testing
- Mechanobiology studies requiring precise deformation control
- Time-dependent testing including creep and stress relaxation
- Multi-angle imaging workflows for improved setup and measurement accuracy
- Advanced hydrated and temperature-controlled testing of living or tissue-mimetic samples

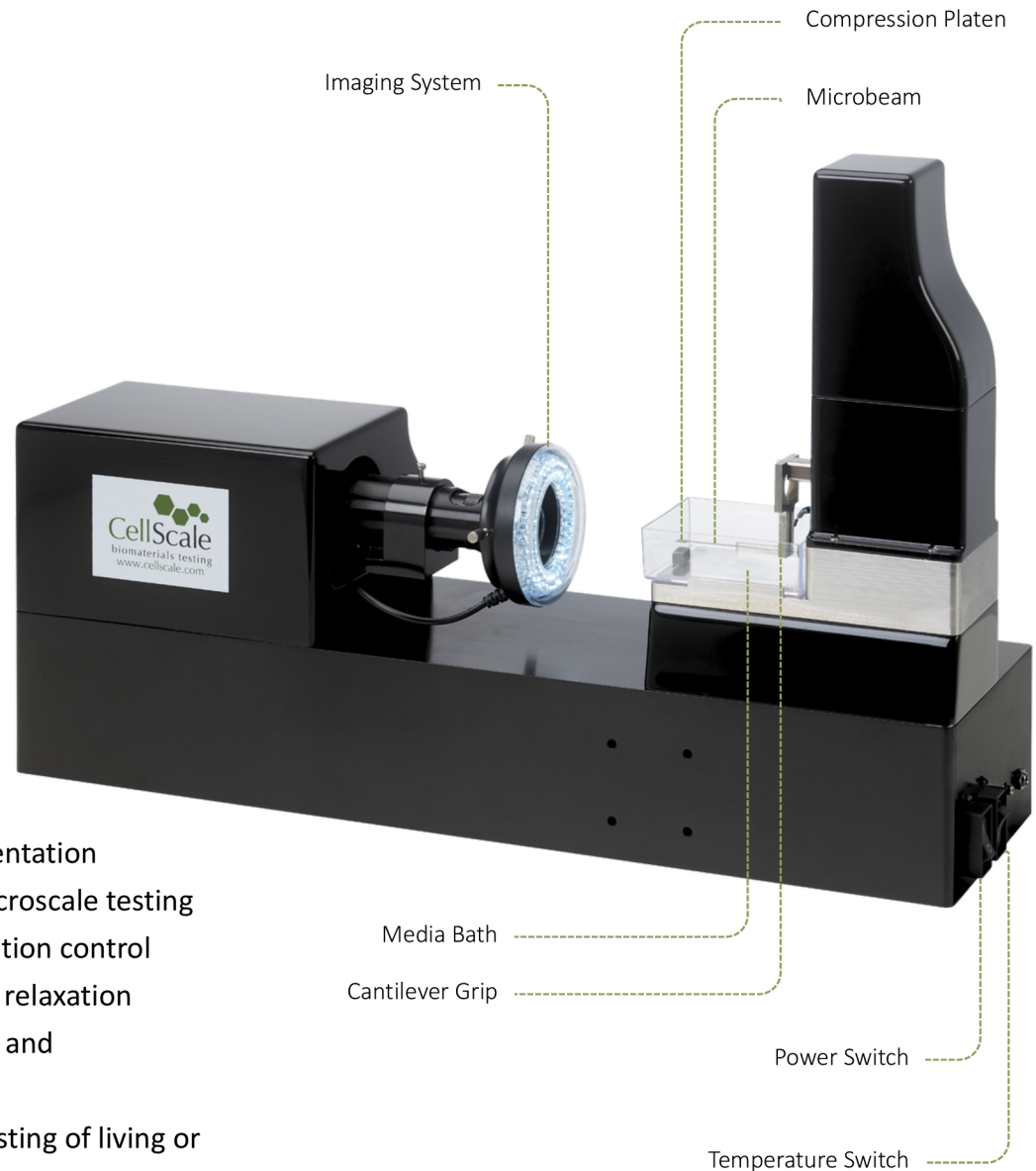

MicroTester Comparison



Specification		LT	G2
Dimensions	(cm)	52 x 17 x 21	56 x 14 x 24
Weight	(kg)	6.5	9
Force Capacity	(mN)	25	
Force Transducer Range	(mN)	0.005 - 25	
Force Accuracy		0.3% of transducer capacity	
Max Grip Separation	(mm)	10	
Sample Thickness Range	(mm)	0.25-5	0.05-10
Max Velocity	(mm/s)	0.5	
Max Cycle Frequency	(Hz)	0.1	0.5
Max Data Rate	(Hz)	5	15
Actuator Technology		Stepper Motor	Piezo-electric Motor
Actuator Resolution	(μm)	1	0.1
Camera Resolution	(px)	1536 x 1536	2048 x 2048
Camera Field of View	(mm)	0.8 - 5.5	0.4 - 11.0
Secondary Camera Option		No	Yes
Shear Axis Option		No	Yes

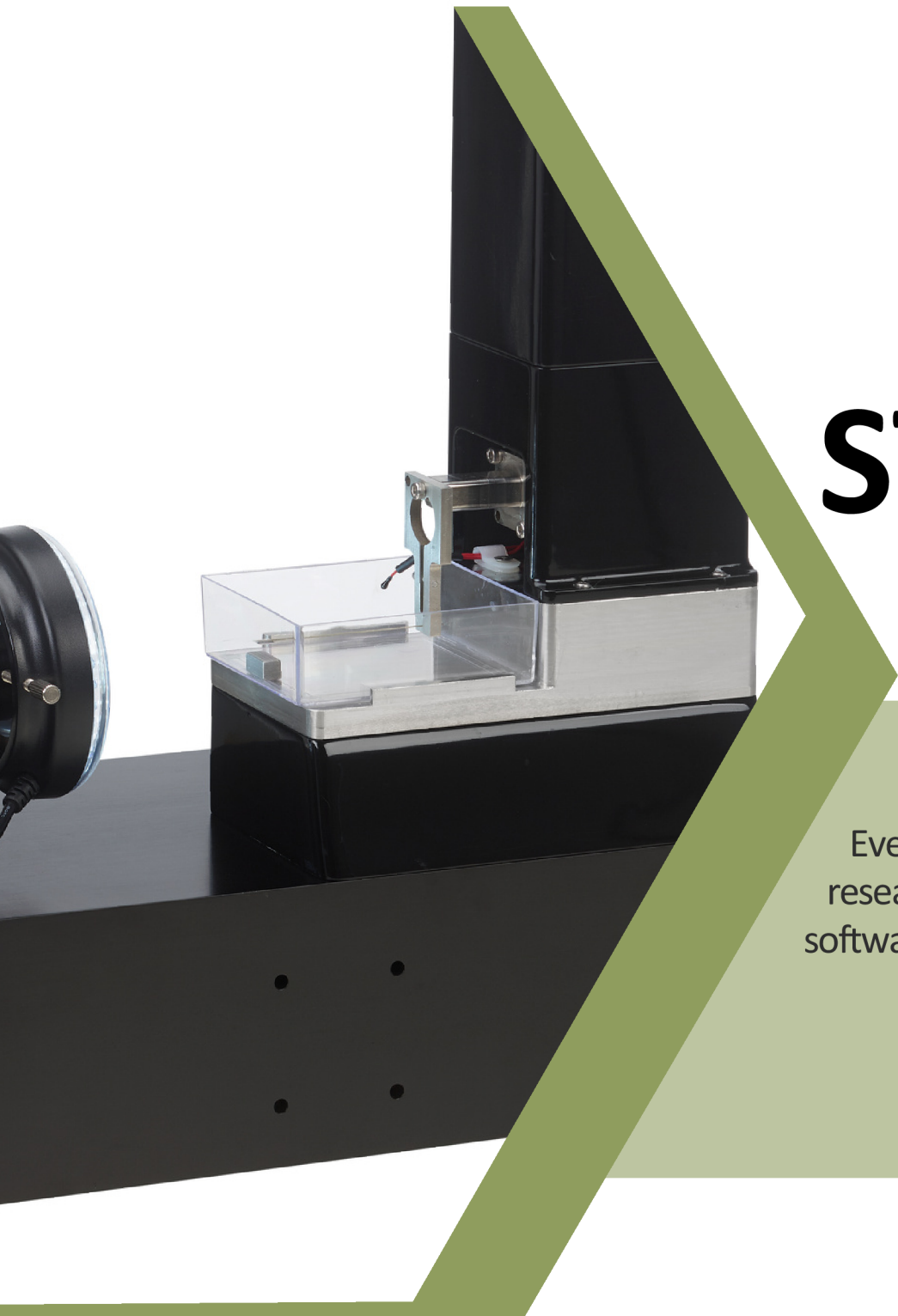

STANDARD FEATURES

Every MicroTester system is delivered as a complete, research-ready platform with the core hardware and software needed to begin testing from day one.

Included with the MicroTester

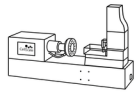

MicroTester Test Frame & Controllers



Integrated Imaging System

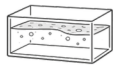

Temperature-Controlled Media Bath



Set of Microbeams (Force Transducers)

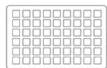

Set of Compression Platens

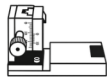

Standard Accessories
(Cantilever Grips, Z-Axis Stage, Adhesive Kit, Calibration Kit)



10 Hours of Remote Installation and Training



Lifetime License to LabJoy Test Control Software



Lifetime License to Data Analysis Software



Lifetime Technical Support



12 Month Warranty

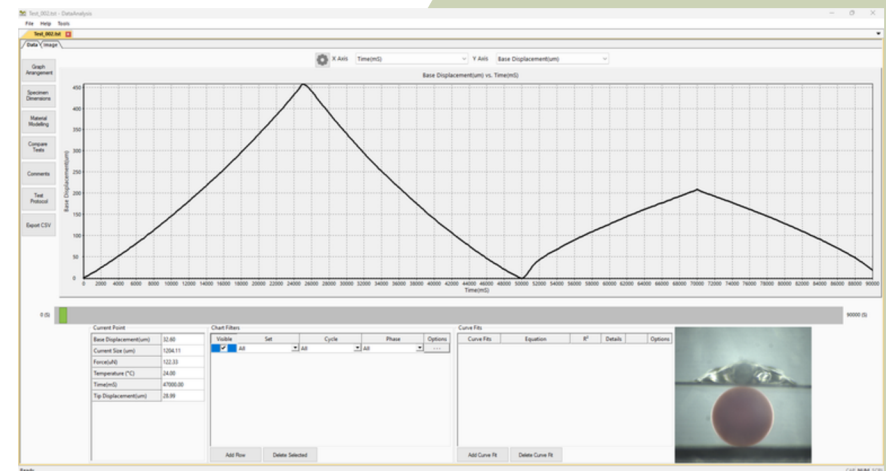

Integrated Imaging System



Digital Image
Correlation

The integrated imaging system on the MicroTester enables quantitative image tracking during mechanical testing, implementing the image-based force and displacement measurements unique to the MicroTester, while offering digital image correlation (DIC), strain measurement, and strain mapping in CellScale's LabJoy software. It allows researchers to combine force and displacement data with non-contact optical deformation measurement for workflows where local strain analysis, deformation validation, and synchronized visual observation are important.

NOTE: Imaging is included with both the MicroTester LT and MicroTester G2. The G2 includes a higher resolution imaging system with a wider field of view and optional secondary imaging upgrades.

Integrated Imaging System

Key Features

- Supports the image-based force and displacement measurements unique to the MicroTester
- Enables image-based strain measurement and strain mapping in CellScale LabJoy software
- Synchronized image capture during testing for playback, documentation, and deformation analysis
- MicroTester G2 camera: 2048 × 2048 pixels, field of view 0.4 mm to 11.0 mm
- MicroTester LT camera: 1536 × 1536 pixels, field of view 0.8 mm to 5.5 mm
- Motorized XYZ positioning supports specimen setup, alignment, and focusing
- Improves confidence in results by helping verify alignment, contact definition, and localized deformation

Common Uses

- DIC and image-based tracking for non-contact deformation measurement and strain mapping
- Compression and indentation testing where imaging helps confirm alignment, contact position, and localized specimen response
- Testing of hydrogels, microspheres, spheroids, organoids, scaffolds, and other small soft constructs where geometry and positioning strongly affect the result
- Viscoelastic, cyclic, creep, and stress relaxation studies where synchronized imaging improves interpretation of time-dependent behaviour
- Hydrated and temperature-controlled testing where optical tracking supports repeatable analysis in physiologically relevant conditions



Media Bath

The MicroTester's media bath enables immersed mechanical testing for hydrated biological specimens, soft biomaterials, and engineered microscale constructs. With integrated heating up to 40 °C, the media bath is included as a standard feature on both the MicroTester LT and MicroTester G2.

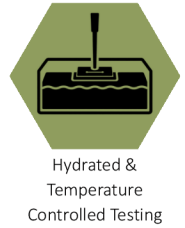

MicroTester Media Bath

Key Features

- Heated media bath included as standard with both MicroTester models
- Integrated temperature monitoring for controlled test conditions
- Media heating up to 40 °C
- 120 mL bath capacity
- Supports hydrated and temperature-controlled testing workflows
- Well suited for physiologically relevant testing of soft, microscale specimens
- 3 included with initial purchase
- Available for re-order as a replaceable component to ensure maximal optical clarity



Common Uses

- Hydrated compression and tension testing of soft biological specimens
- Mechanical characterization of hydrogels and cell-laden materials in fluid
- Testing of spheroids, organoids, and microtissues in immersed conditions
- Creep, viscoelastic, and stress relaxation studies where hydration affects response
- Temperature-controlled testing near physiological conditions
- Research workflows where immersion helps preserve soft specimen integrity during testing



Microbeams



Compression Testing



Indentation Testing



Tensile Testing



Shear Testing

Microbeams are central to the MicroTester measurement approach, acting as both the load applicator and the force transducer during testing. This design gives the system exceptional sensitivity for ultra-low force measurement and allows researchers to match beam performance to the stiffness and expected force range of the specimen.

Microbeams / Force Transducers

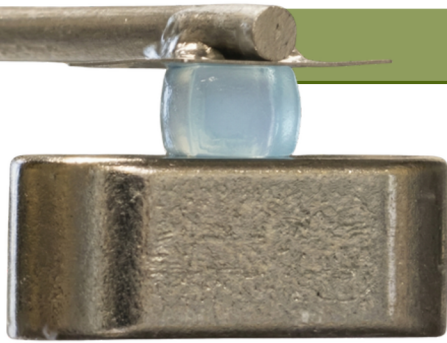

Selecting the right microbeam is an important part of MicroTester setup. Lower-capacity beams provide greater sensitivity for very soft, low-force samples, while higher-capacity beams are better suited for stiffer specimens or tests requiring a larger force range. With force accuracy of approximately 0.2% of transducer capacity, the MicroTester supports reliable force measurement across a wide range of microscale compression, tension, indentation, and other low-force testing workflows.

Features & Specifications

- Interchangeable options to match specimen stiffness and force range:
 - 7 standard microbeam wire sizes:
 - from 0.0762mm to 0.5588mm width
- Force accuracy of approximately 0.2% of transducer capacity
- Set of ten microbeams for all 7 standard sizes included with both MicroTester models
- Available for re-order for routine MicroTester use



Standard Capacities

- 0.005 mN
- 0.02 mN
- 0.08 mN
- 0.2 mN
- 1 mN
- 5 mN
- 25 mN

±0.2% accuracy

Compression Platens



Compression platens are the standard contact fixtures used for unconfined compression testing on the MicroTester. They provide defined contact areas for loading small, soft, and delicate specimens under controlled compressive displacement.

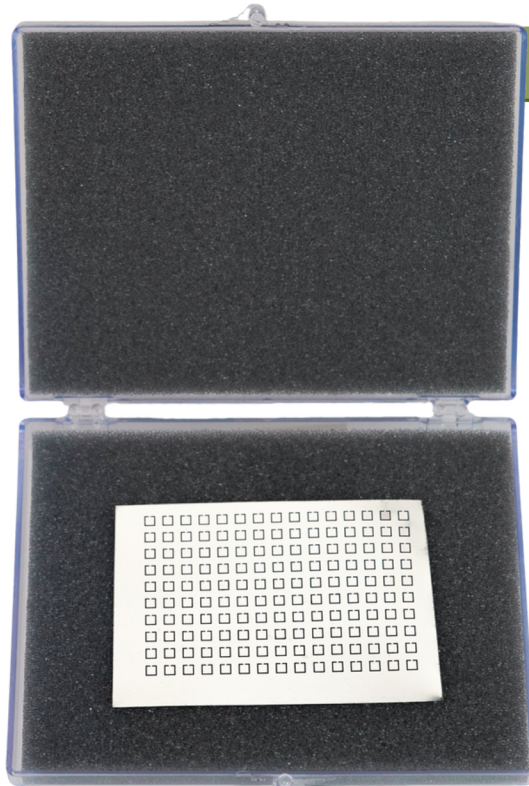

MicroTester Platens

The MicroTester LT and MicroTester G2 each include stainless steel compression platens in six sizes, giving researchers flexibility to match contact geometry to specimen dimensions and test objectives. Each system includes 1 mm-6mm square compression platens to support a wide range of sample sizes for microscale compression workflows.

Uses & Benefits

- Supports unconfined compression testing of soft microscale samples
- Multiple stainless steel platen sizes help match contact area to specimen size
- Improves consistency of specimen loading and contact geometry
- Useful for hydrogels, microtissues, organoids, spheroids, and other compliant materials
- Min. 40 of each size included with initial purchase
- Available for re-order for routine MicroTester use

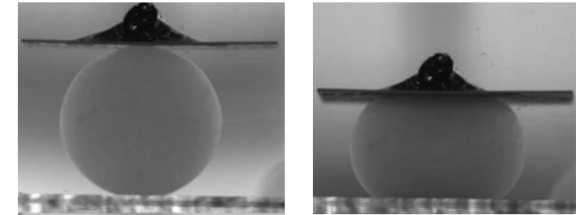

Hydrogel **Compression Testing**

Platen Sizes

- 1 mm
- 2 mm
- 3 mm
- 4 mm
- 5 mm
- 6 mm

LabJoy Test Software

Our LabJoy Test Control Software is the test execution environment used to design, run, and monitor mechanical testing protocols on the MicroTester. It is separate from Data Analysis Software and focuses on protocol setup, real-time control, and synchronized capture of mechanical data and images during testing.

NOTE: A Windows 11-based PC with 2x USB 3.x ports is required to run LabJoy software and connect to the MicroTester

What It Does:

- Creates and runs standard and custom test protocols using a table-based parameter editor
- Provides real-time monitoring of force, displacement, and test progress during setup and testing
- Saves repeatable methods using protocol files and reusable templates

Protocol Design and Control:

- Supports common test phases such as ramps, sinusoids, holds, and cyclic segments
- Control capabilities include displacement control, force control, and multiphase protocol design for a wide range of microscale testing methods

Imaging & Data:

- Captures time-stamped force and displacement test data to CSV for analysis and reporting
- Supports synchronized image capture during testing for playback, documentation, and image-based analysis
- Imaging capabilities vary by model, with the G2 offering higher resolution, a wider image field of view for a larger range of sample dimensions, and an optional secondary camera upgrade.

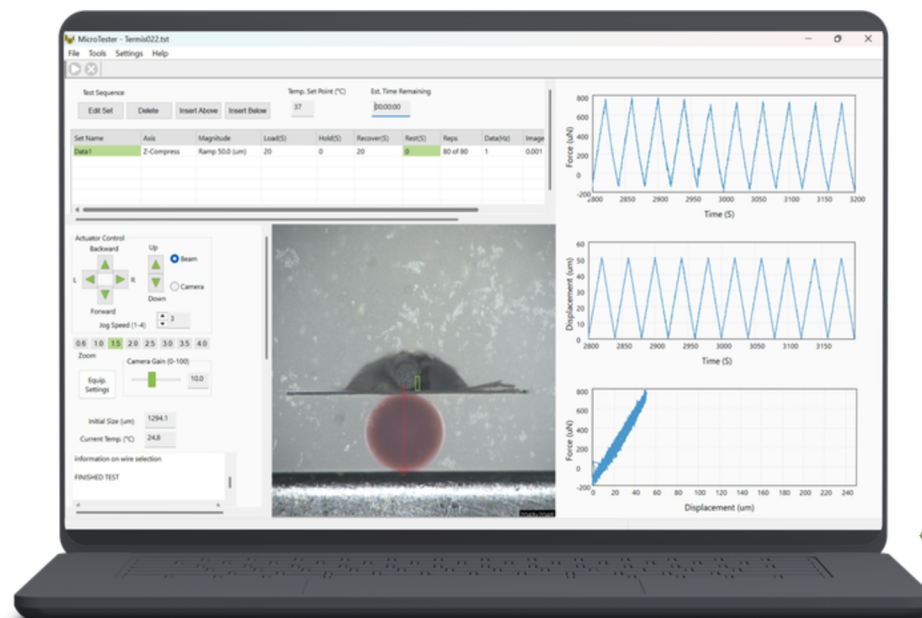

Data Analysis Software

The MicroTester Data Analysis Software is a post-test analysis environment for interpreting microscale mechanical testing results, turning time-synchronized force, displacement, and image data into force-displacement curves, stress-strain curves, curve fits, and publishable material properties. It supports comparisons across repeated tests and synchronizes mechanical datasets with captured images for clearer interpretation, reporting, and image-based strain analysis.

What It Does:

- Post-test mechanical testing data analysis for force, displacement, stress, and strain
- Generation and comparison of force-displacement and stress-strain curves
- Material property extraction tools, including calculation of stiffness, modulus, and other derived parameters
- Support for viscoelastic analysis including creep, stress relaxation, hysteresis, and cyclic testing

Visualization and Comparison:

- Comparison of repeated tests or grouped datasets for clearer interpretation
- Customizable graphs for reporting, figure preparation, and publication workflows
- Synchronized review of mechanical data and captured images

Imaging and Export Tools:

- Image-based review and sample dimension measurement tools
- Non-contact, full-field strain measurement using image-based tracking and DIC analysis
- Images and video outputs for sharing, reporting, and publication workflows
- Export of CSV data to other data handling platforms for alternative material modelling

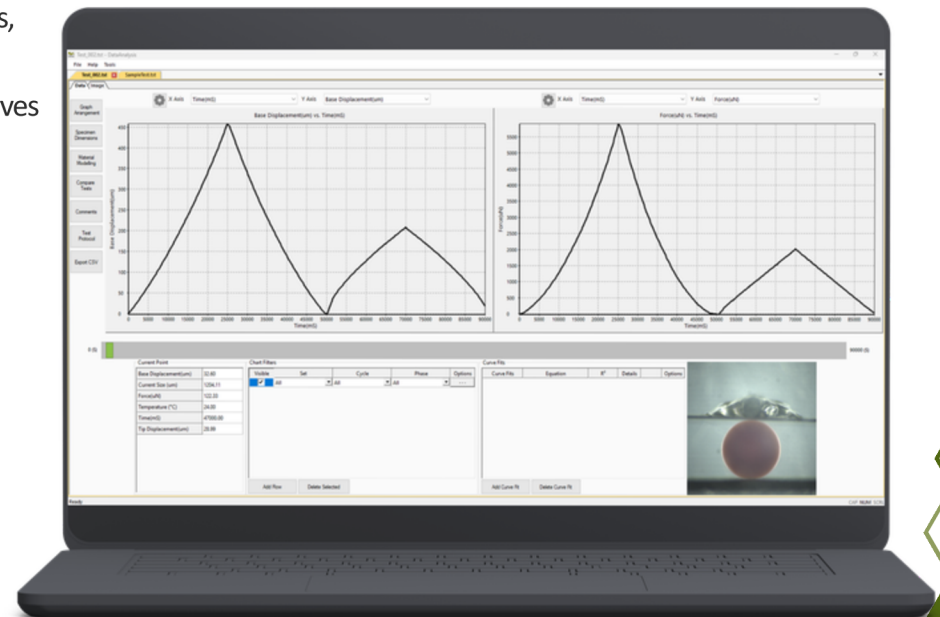

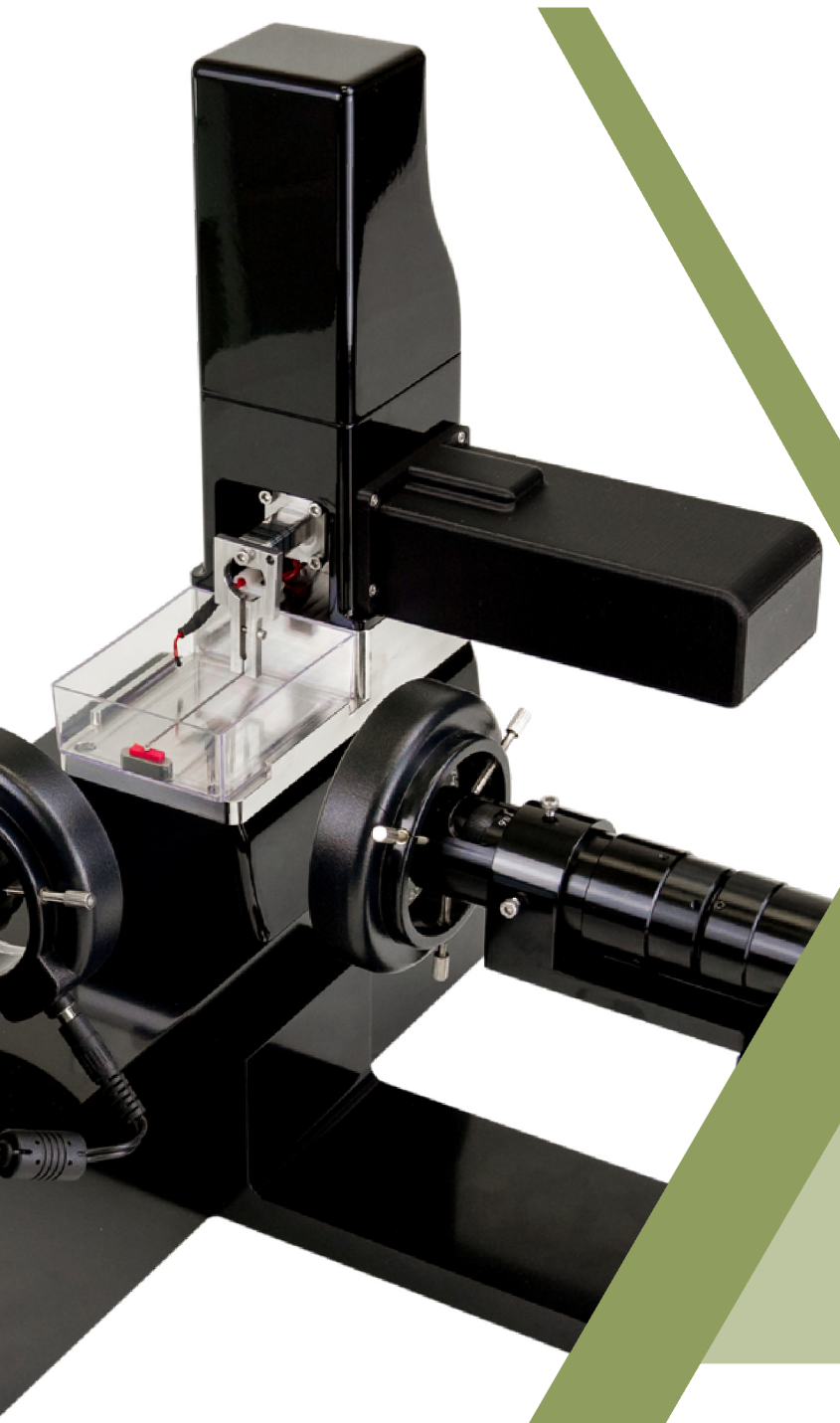

BUILD UPGRADES

The MicroTester G2 can be expanded with hardware upgrades that add new test configurations and improve visual access during setup and testing. These build upgrades extend the platform beyond standard micro-scale compression workflows, supporting more specialized applications that require lateral loading or additional imaging perspectives.

Shear Axis Upgrade



Shear Testing

The Shear Axis Upgrade adds a secondary test direction to the MicroTester G2 for controlled lateral displacement of small specimens, assemblies, and interfaces. It expands the system beyond standard compression workflows, enabling shear-based characterization at the micro-scale.

NOTE: Only available on the MicroTester G2

Shear Axis

With the Shear Axis Upgrade, researchers can apply precise lateral motion to evaluate shear response, detachment behaviour, interfacial failure, and other off-axis mechanical events in small and delicate samples. This makes the MicroTester G2 well suited for applications where separation force, shear fracture, or lateral displacement response are important.

Common Shear Axis Uses

- Shear testing of microfeatures and separable microstructures
- Detachment and fracture force testing under controlled lateral displacement
- Interfacial mechanics of bonded, layered, or attached microscale samples
- Shear response of soft biomaterials and compliant polymer structures
- Studies where lateral release or detachment must be quantified
- Small-sample research workflows where off-axis loading is needed in addition to compression or tension

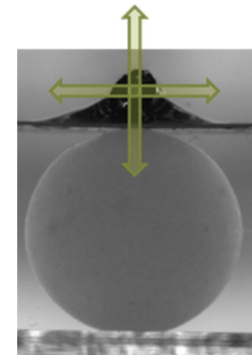

Hydrogel **Shear Testing**

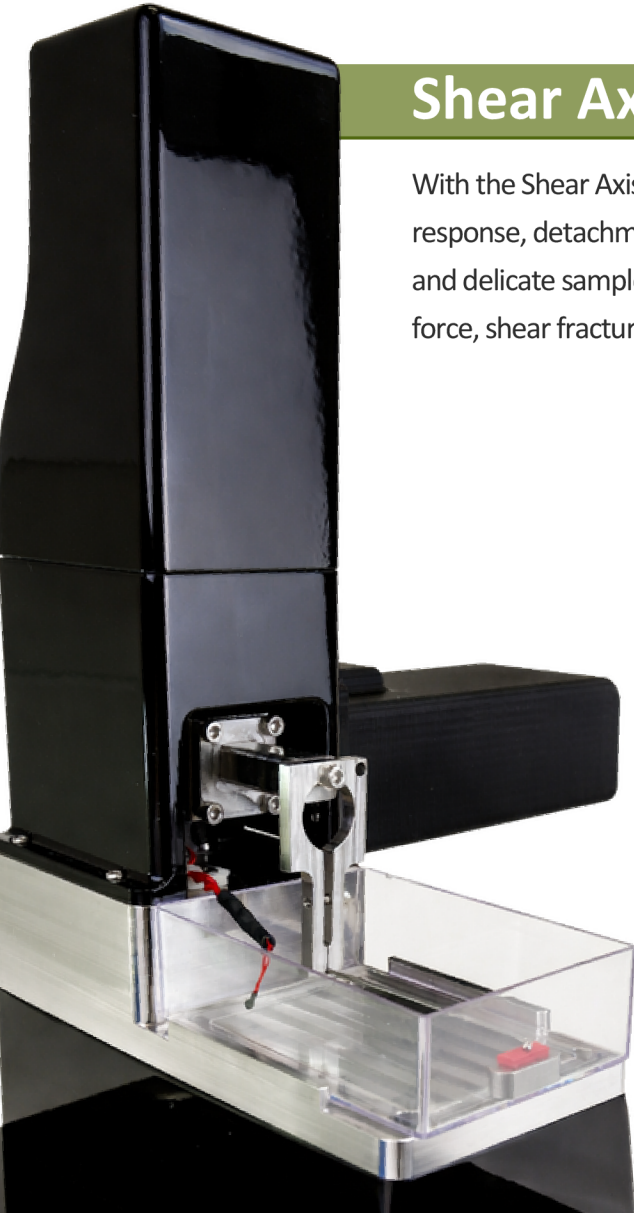

Secondary Imaging Upgrade

The Secondary Imaging Upgrade adds a second imaging axis and camera to the MicroTester G2 for improved specimen visibility, alignment, and image-based analysis from an additional viewpoint. This can improve setup confidence and provide clearer observation of deformation, contact, and test events that may be difficult to interpret from a single camera angle.

NOTE: Only available on the MicroTester G2



Secondary Imaging

Adds a second camera to provide another visual perspective during specimen setup and testing. This can improve alignment, help confirm fixture interaction, and support workflows where visibility from an alternate view is important.

Benefits of a Secondary Camera

- Improved specimen setup accuracy from an additional viewing angle
- Better alignment of very small or delicate specimens and fixtures
- Clearer observation of contact, deformation, and failure events during testing
 - Greater confidence in image-based analysis for complex or specialized workflows
- Easier interpretation of off-axis motion, lateral displacement, or interface behaviour
- Improved documentation and reporting with complementary visual perspectives



ADDITIONAL TEST FIXTURES

The MicroTester can be configured with specialty fixtures that extend the platform beyond compression and shear workflows. These accessories support application-specific test methods such as spherical indentation and 3-point tension testing, helping researchers adapt the system to unique specimen geometries and measurement needs.

Indentation Testing

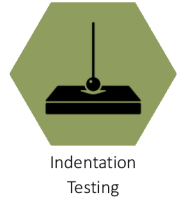

Spherical indentation expands the MicroTester's capabilities for localized mechanical characterization of very small, soft, and delicate specimens. It is well suited for applications where contact geometry, local stiffness, and regional material response are important.

Spherical Indentation Fixture

Using spherical indenters of defined size, the MicroTester can apply controlled compressive contact to evaluate local response in soft materials and microscale constructs. Spherical indenter kits are available with 0.5 mm, 1 mm, and 1.5 mm diameter, giving researchers flexibility to match contact geometry to specimen size and test objectives.

Features & Specifications

- Spherical indentation testing for localized mechanical characterization
- Compatible with MicroTester G2 and MicroTester LT
- Spherical indenter kit includes stainless steel indenters in 0.5 mm, 1 mm, and 1.5 mm diameters
- Supports testing of soft, small, and delicate specimens

Common Uses

- Local stiffness measurement of hydrogels and soft biomaterials
- Indentation testing of cell-laden hydrogels and engineered tissue constructs
- Regional mechanical characterization of small biological specimens
- Surface mechanics studies of compliant materials
- Localized probing of organoids and microtissues

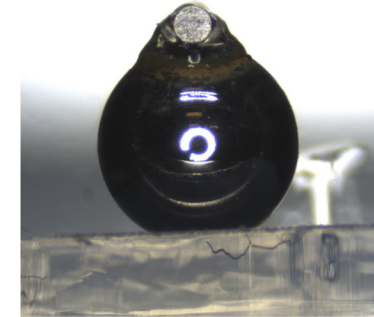

Gel Layer **Spherical Indentation**



3-Point Tension Testing



The U-Channel fixture enables 3-point tension testing on the MicroTester for delicate microscale samples that require an alternative to standard direct gripping. It provides a practical way to evaluate small strip-like or flexible specimens under controlled loading.

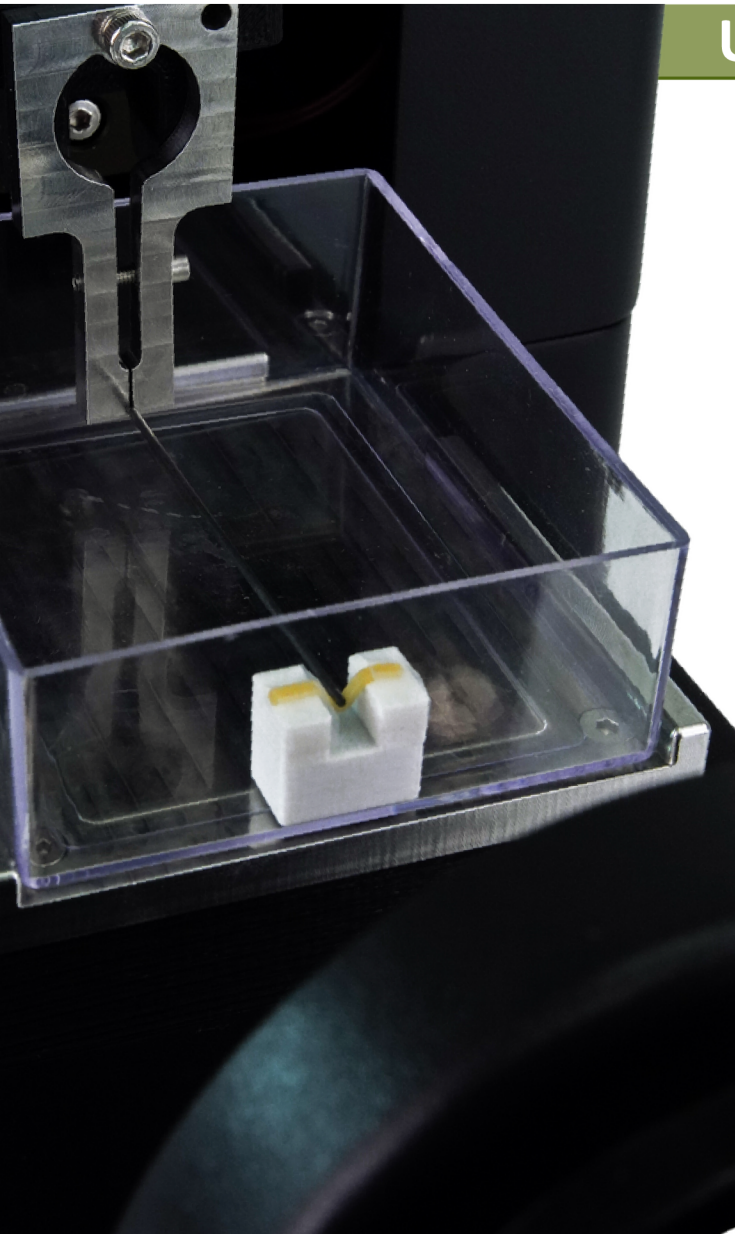

U-Channel Tension Fixture

With the U-Channel accessory, the MicroTester can be configured for tension-style workflows that help reduce handling challenges for delicate samples. This setup is useful for testing small materials and structures where traditional tensile gripping may be difficult or where fixture geometry needs to better match the specimen form.

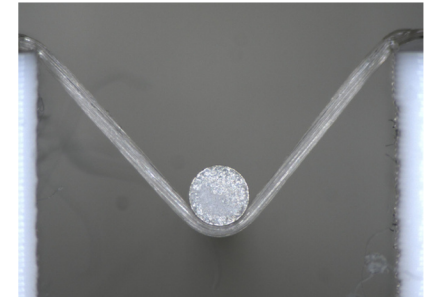

Filament / Fibre / Strip
Tensile Testing

Features & Specifications

- Enables 3-point tension/flexural testing
- Supports alternative tension-style loading geometry for small, flexible samples
- Useful for fibres, strip-like, film-like, and other fragile specimen formats
- Compatible with MicroTester G2 and MicroTester LT
- U-Channel fixture available in 4-pack configuration

Common Uses

- Testing of thin fibres or strip-like microscale specimens
- Evaluation of extensible biomaterials
- Tension-based studies where direct gripping is difficult
- Research workflows requiring alternative loading geometry for fragile samples



STANDARD ACCESSORIES

Several standard accessories help with setup, specimen handling, and application-specific test preparation on the MicroTester, while allowing replacement of system components needed for ongoing use. These components help researchers adapt the system to different sample geometries, improve workflow efficiency, and maintain consistent test setup across routine and specialized microscale testing applications.

Accessories

NOTE: The following accessories are included with your MicroTester purchase; replacement items are available for order



Cantilever Grips

Cantilever grips secure MicroTester microbeams during setup and testing. Standard and large-beam grip options accommodate different microbeam sizes and support stable, repeatable positioning for reliable force measurement.

Uses & Benefits

- Secures microbeams during setup and testing
- Supports stable beam mounting
- Compatible with interchangeable microbeam configurations
- Helps maintain measurement consistency across applications

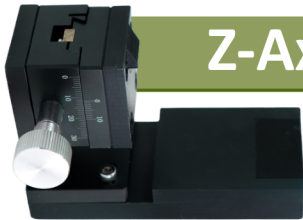

Z-Axis Stage

The Z-axis stage is a manual mounting tool used during microbeam preparation and fixture assembly before installation on the MicroTester. It helps users position the beam, platen, and clamp more precisely, making delicate setup easier and more repeatable.

Uses & Benefits

- Supports precise vertical positioning during beam mounting
- Improves setup accuracy for microbeams and fixtures
- Helps reduce handling difficulty during installation
- Useful for repeatable test preparation
- Supports efficient setup for delicate low-force workflows



Adhesive Kit

The adhesive kit provides adhesive and accelerator for bonding compression platens and specialty fixtures to the microbeam during setup. It helps users prepare beam assemblies efficiently and supports consistent fixture attachment across changing test configurations.

Uses & Benefits

- Supports fixture bonding during setup and preparation
- Helps streamline test configuration changes
- Improves convenience for routine lab workflows
- Supports consistent fixture assembly practices
- Provides a ready-to-use bonding solution



RESEARCH APPLICATIONS

The MicroTester supports research across mechanobiology, tissue engineering, and micro-scale biomechanics applications, particularly where very low force measurement, controlled loading, imaging, and meaningful specimen deformation are important. The MicroTester helps researchers study small, soft, and delicate specimens under conditions that better reflect real environments.

Applications & Sample Types

The MicroTester is used in many biomaterials, mechanobiology, and tissue engineering research labs where accurate ultra-low force testing and meaningful small-sample deformation matter. With strong use across compression, indentation, hydrated testing, and time-dependent workflows, it helps researchers study soft materials and microscale biological systems under physiologically relevant and experimentally controlled conditions.



Hydrogel Mechanical Testing

Hydrogels, cell-laden hydrogels, crosslinked matrices, cultured matrices, injectable gels, other water-rich engineered systems



Biomaterials and Bioinks

Soft polymers, injectable biomaterials, bioinks, bioprinted constructs, compliant biomaterials, living biomaterial systems



Microtissue, Spheroid, and Organoid Mechanics

Spheroids, organoids, microtissues, tissue mimetics, small *in vitro* models, multicellular aggregates



Mechanotransduction and Stem Cell Mechanics

Cell-matrix interactions, stiffness-dependent response, force-sensitive remodeling, stem cell mechanobiology workflows



Injectable and Regenerative Biomaterials

Injectable hydrogels, regenerative matrices, therapeutic biomaterials, delivery scaffolds, repair-oriented soft materials



ECM and Decellularized Matrix Mechanics

Decellularized matrices, ECM-derived hydrogels, tissue-derived scaffolds, matrix remodeling systems



Drug Screening and Delivery Mechanics

Drug response models, treatment-induced stiffness changes, microneedles, therapeutic delivery materials, screening platforms



Organ-on-a-Chip and Microscale Tissue Models

Organ-on-a-chip constructs, microphysiological systems, engineered microenvironments, cultured microscale tissues

MicroTester Use Cases

Researchers use the MicroTester to characterize very small, soft, and delicate specimens under loading conditions that better reflect real microscale mechanical behaviour. Across published studies, the platform is most commonly used to evaluate stiffness, viscoelasticity, local deformation, treatment effects, and structure-function relationships in hydrogels, living constructs, and tissue-mimetic systems.

Hydrogel and Soft Biomaterial Characterization

Used for compression and indentation testing of hydrogels, soft polymers, injectable formulations, and compliant biomaterials where stiffness, modulus, and time-dependent response are important

Cell-Laden and Living Material Workflows

Used to evaluate cell-laden hydrogels, bioprinted constructs, and living engineered materials in workflows where hydrated and temperature-controlled testing helps preserve relevant specimen behaviour

Organoid, Spheroid, and Microtissue Mechanics

Used to measure deformation, compression response, and mechanical phenotype in small 3D biological models such as spheroids, organoids, multicellular aggregates, and microtissues

Mechanotransduction and Remodeling Studies

Used in studies linking structure, stiffness, deformation, and biological response across engineered matrices, regenerative materials, and cell-responsive soft systems



Comparative Treatment and Formulation Studies

Used to compare how formulation, crosslinking, culture conditions, incubation, disease modeling, or treatment exposure affect the mechanics of soft microscale samples

Image-Enabled Micro Mechanical Testing

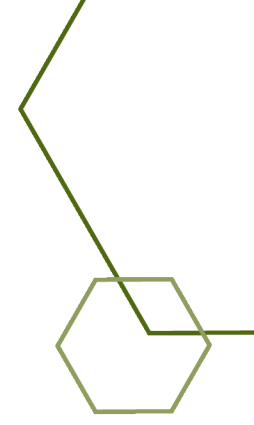
Used in workflows where synchronized imaging, DIC, and strain mapping improve interpretation of localized deformation, heterogeneous response, contact behaviour, and small-sample mechanics



 www.cellscale.com
 +1-519-342-6870
 5-564 Weber Street N
Waterloo, ON N2L 5C6
Canada